

# HSK50

سیستم اسکای لایت

## Sky Light System

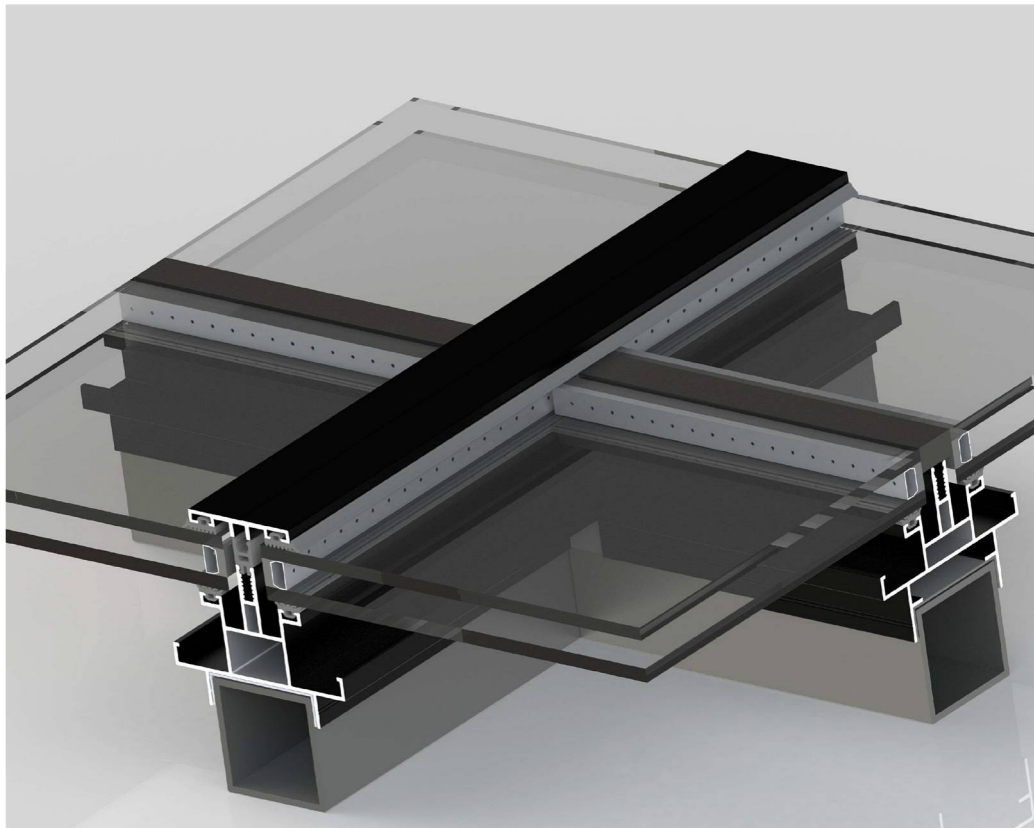

### مشخصات سیستم

- \* اندازه ی عرض پروفیل : 84.5 mm
- \* ضخامت دیواره ی پروفیل : 1.8mm
- \* دارای لاستیک های استاندارد برای آب بندی و هوا بندی نما
- \* - یو چنل - نیم کپ - امکان اجرای نمای کپ دار

## سیستم اسکای لایت - HSK50

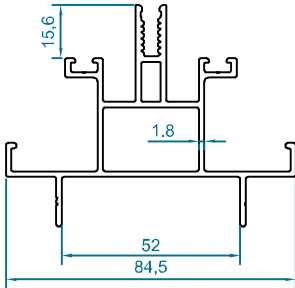

code : 3009  
 پروفیل عمودی  
*Mullion Profile*  
 weight : 1.60 kg/m  
 $J_x = 16.14 \text{ cm}^4$   
 $J_y = 23.97 \text{ cm}^4$

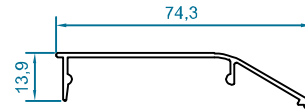

code : 3117  
 درپوش افقی  
*Cover Cap Profile*  
 weight : 0.39kg/m

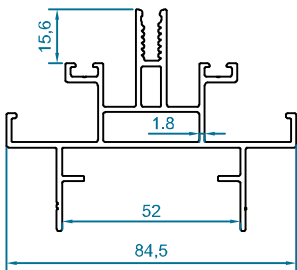

code : 3061  
 پروفیل افقی  
*Transom Profile*  
 weight : 1.67 kg/m  
 $J_x = 27.05 \text{ cm}^4$   
 $J_y = 13.02 \text{ cm}^4$

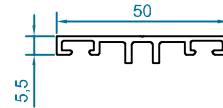

code : 3161  
 پروفیل درپوش  
*Cover Cap Profile*  
 weight : 0.41kg/m

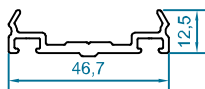

code : 3116  
 نگهدارنده ی شیشه  
*Pressure Plate Profile*  
 weight : 0.49kg/m

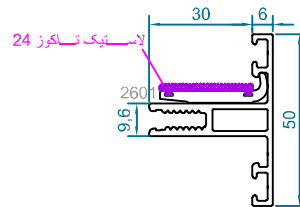

code : 3150  
 پروفیل اضافه  
*Add on Profile*  
 weight : 0.78kg/m

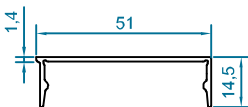

code : 3119  
 درپوش افقی  
*Cover Cap Profile*  
 weight : 0.32kg/m

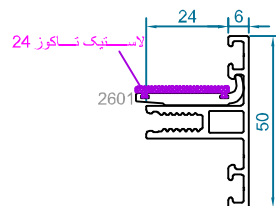

code : 3159  
 پروفیل اضافه  
*Add on Profile*  
 weight : 0.74kg/m

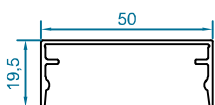

code : 3113  
 پروفیل درپوش  
*Cover Cap Profile*  
 weight : 0.40kg/m

## HSK50 - SKYLIGHT SYSTEM

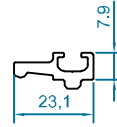
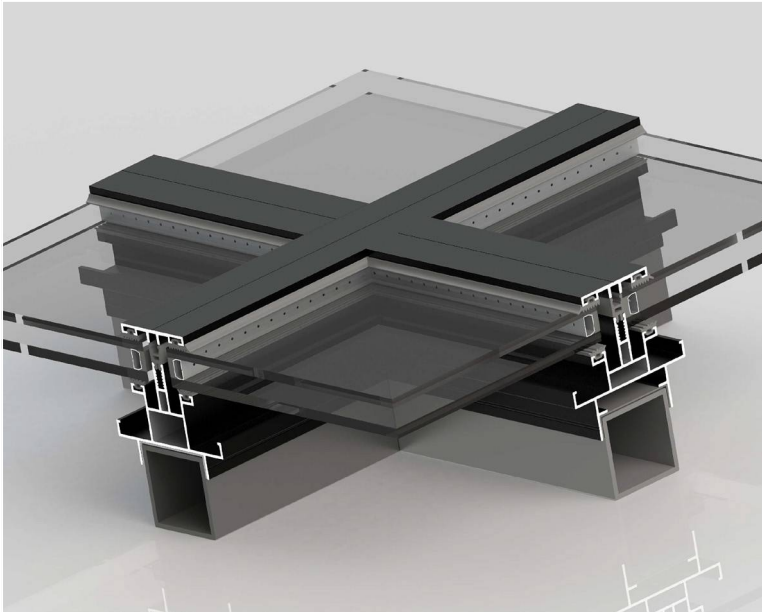

code : 3162  
 تاگل اسکای لایت  
*Fixation Profile*  
 weight :0.31kg/m

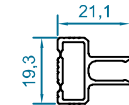

آندادایز مشکی مات

code : 2606  
 اسپیسر یو چنل  
*Glazing Profile*  
 weight :0.280kg/m

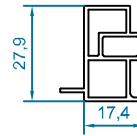

code : 2607  
 آداپتور ورق کامپوزیت  
*Composite Panel Adapter*  
 weight :0.45kg/m

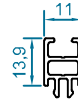

code : 3121  
 پروفیل آداپتور شیشه  
*Single Glazing Profile*  
 weight :0.2kg/m





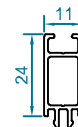





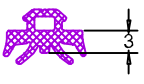

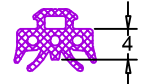
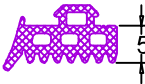
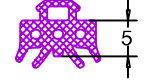
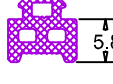
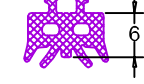

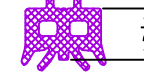

code : 3122  
 پروفیل آداپتور شیشه  
*Single Glazing Profile*  
 weight :0.22kg/m

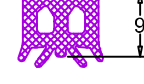

code : 3124  
 پروفیل آداپتور شیشه  
*Single Glazing Profile*  
 weight :0.27kg/m

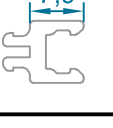
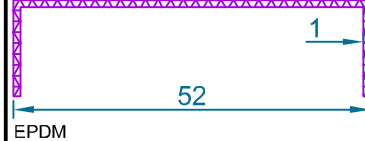
ACCESSORIES LIST

DRAWING	CODE	DESCRIPTION	DRAWING	CODE	DESCRIPTION
 EPDM	CF.03 (3 MM)	لاستیک شیشه کرتین وال Facade Glazing Gasket 168metr/10kg	 EPDM	KF.30 (3 MM)	لاستیک نگهدارنده under cover outhter glazing gasket 132metr/10kg
 EPDM	CF.04 (4 MM)	لاستیک شیشه کرتین وال Facade Glazing Gasket 148metr/10kg	 EPDM	KF.50 (5 MM)	لاستیک نگهدارنده under cover outhter glazing gasket 102metr/10kg
 EPDM	CF.05 (5 MM)	لاستیک شیشه کرتین وال Facade Glazing Gasket 117metr/10kg	 EPDM	MF.06 (5.8 MM)	لاستیک پیچ نگهدارنده center pressure gasket 127metr/10kg
 EPDM	CF.06 (6 MM)	لاستیک شیشه کرتین وال Facade Glazing Gasket 102metr/10kg	 EPDM	MF.08 (8 MM)	لاستیک پیچ نگهدارنده center pressure gasket 107metr/10kg
 EPDM	CF.07 (7 MM)	لاستیک شیشه کرتین وال facade glazing gasket 92metr/10kg	 EPDM	STF.30	لاستیک فیکس یو چنل central gasket 95metr/10kg
 EPDM	CF.08 (8 MM)	لاستیک شیشه کرتین وال facade glazing gasket 82metr/10kg	 aluminium	STF-31	گونهای آلومینیومی اسپیسر یو چنل corner joint
 EPDM	CF.09 (9 MM)	لاستیک شیشه کرتین وال facade glazing gasket 77metr/10kg	 pvc	STF-32	گونهای پلاستیکی اسپیسر یو چنل corner joint
 EPDM	CF.10 (10 MM)	لاستیک شیشه کرتین وال facade glazing gasket 72metr/10kg	 EPDM	KF.10	لاستیک کرتین وال نیم کپ central epdm gasket 57metr/10kg
 EPDM	CF.11 (11 MM)	لاستیک شیشه کرتین وال facade glazing gasket 67metr/10kg	 pvc	PVC028	آداپتور پی وی سی کرتین وال pvc profiles
 EPDM		code : SK-50 لاستیک ایزولاسیون اسکای لایت isolason gasket	 pvc	PVC094	آداپتور پی وی سی کرتین وال pvc profiles

## Hsk50 - SKYLIGHT SYSTEM

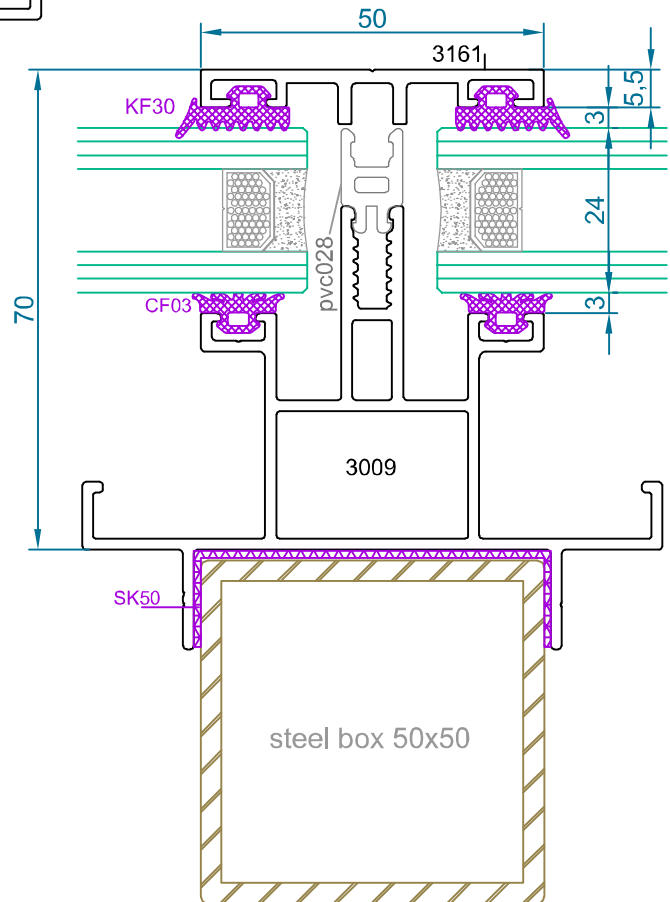
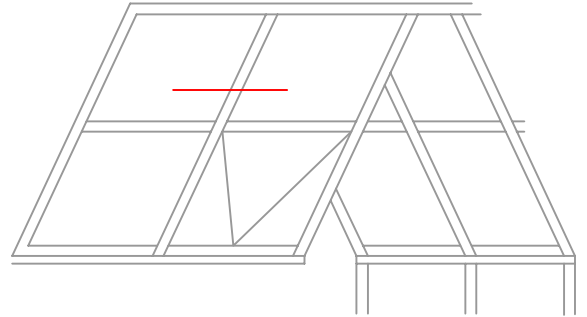
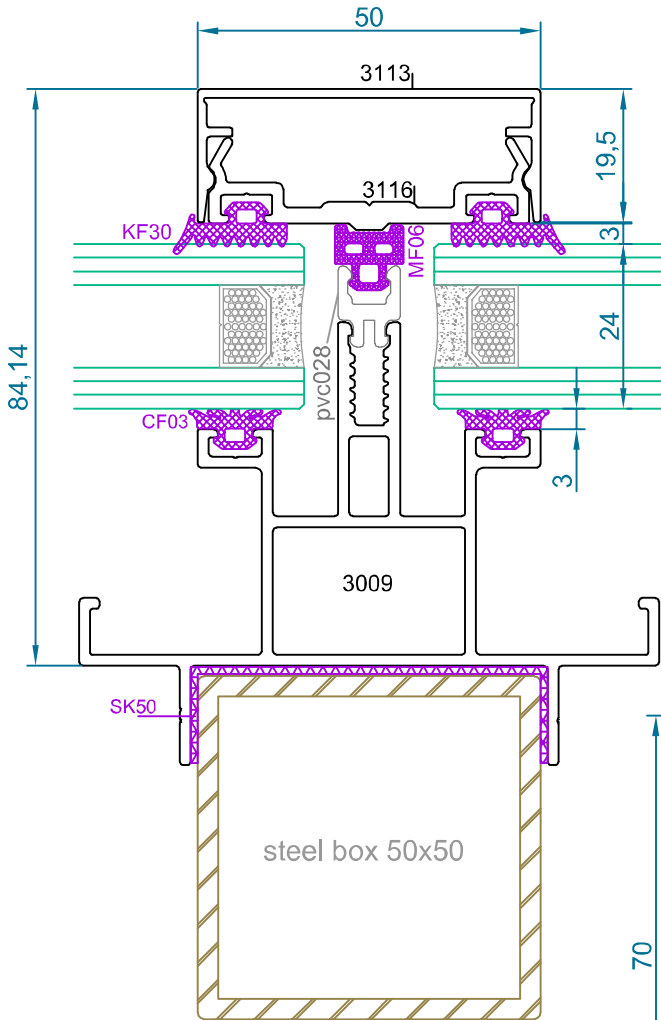

## سیستم اسکای لایت - HSK50

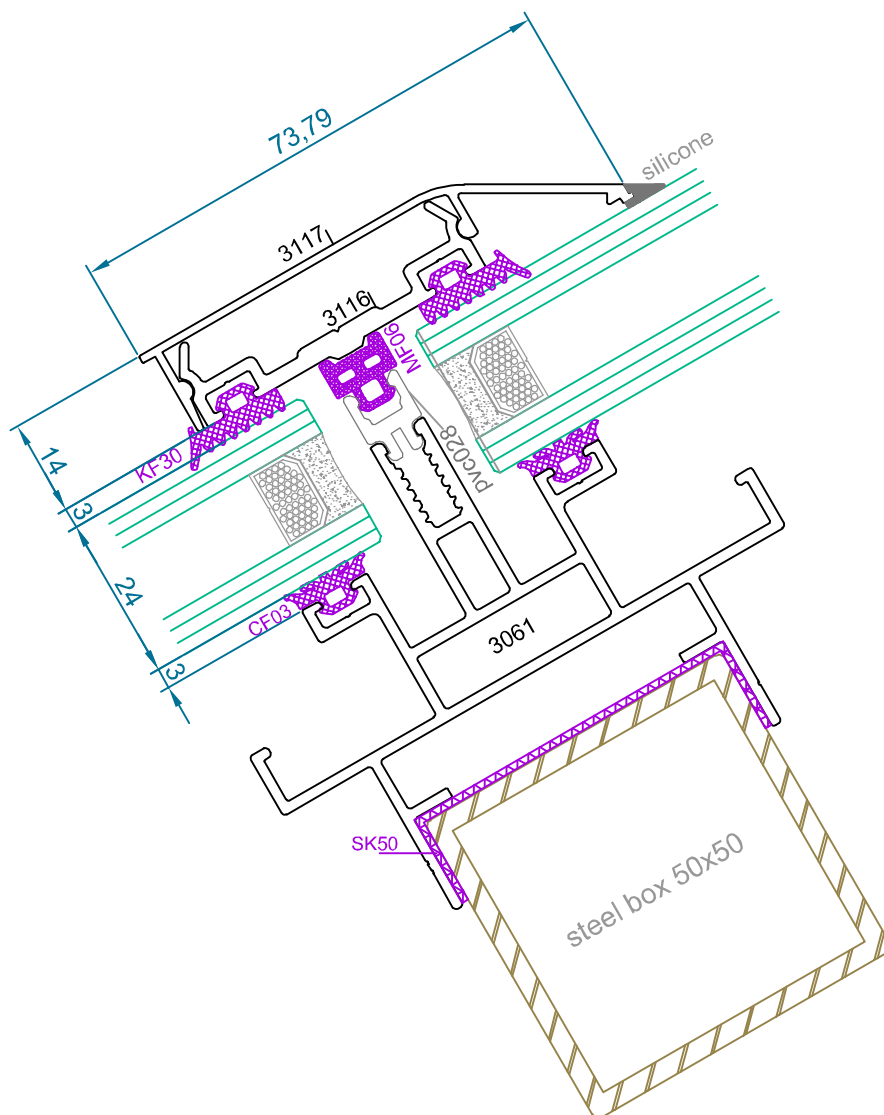
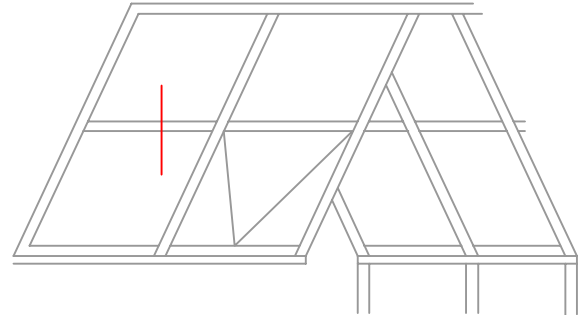

## HSK50 - SKYLIGHT SYSTEM

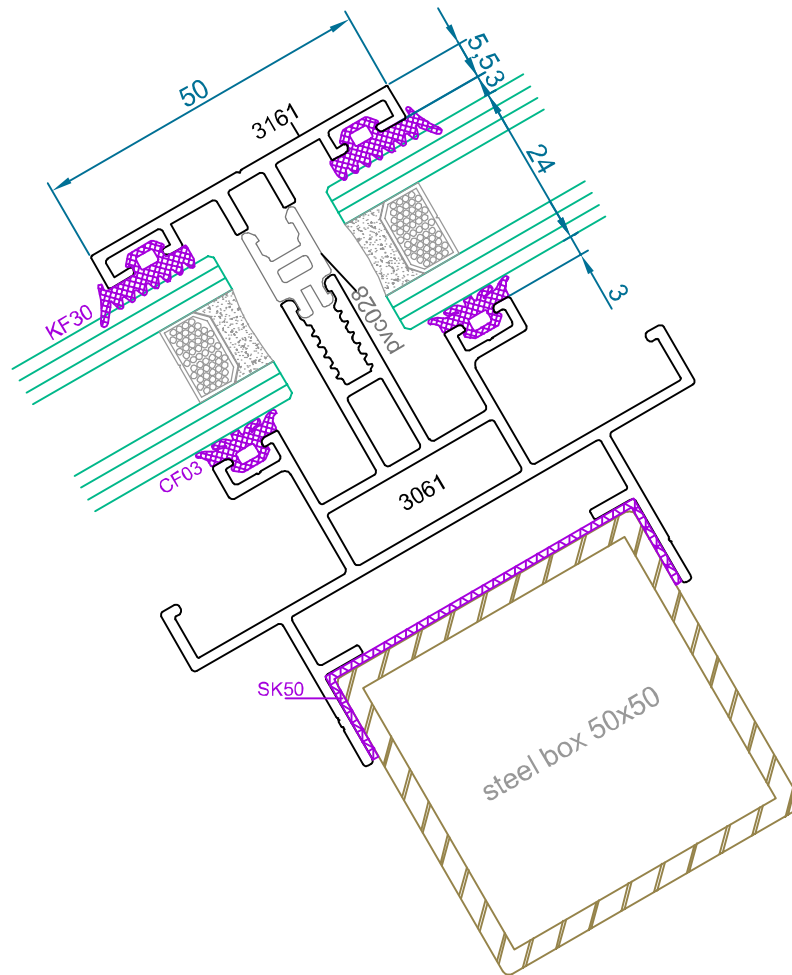
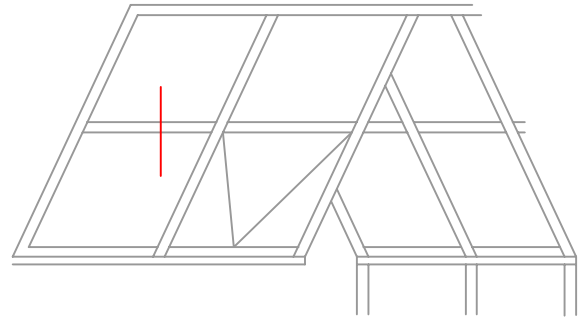



## سیستم اسکای لایت - HSK50

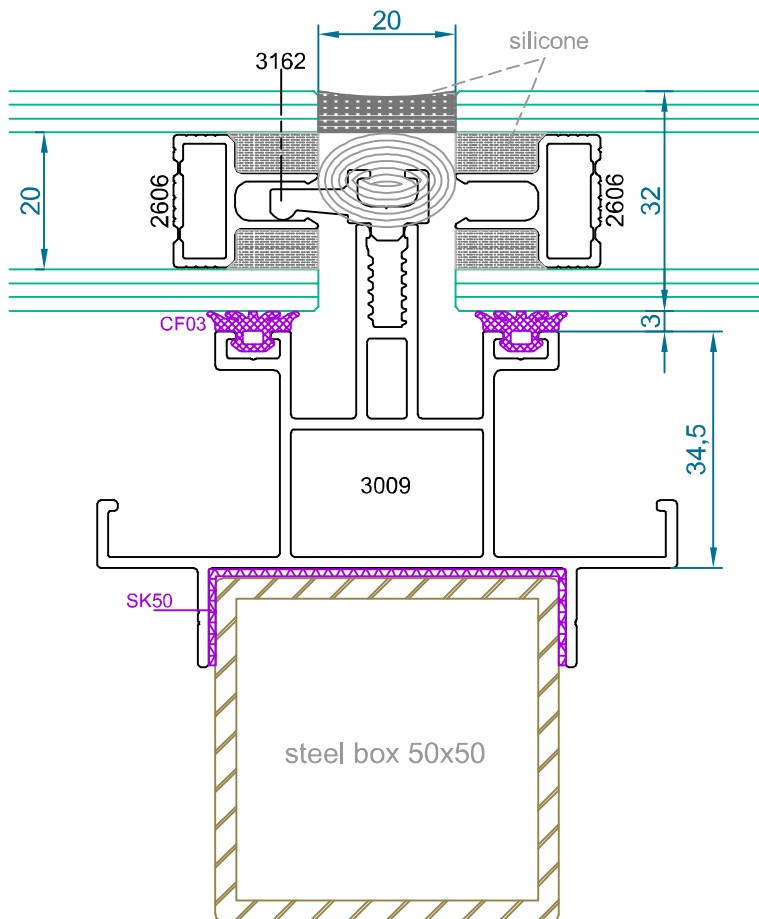
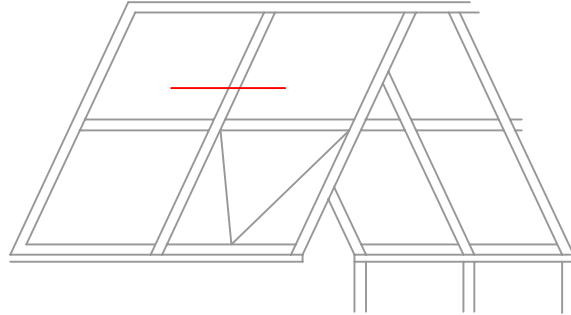



## HSK50 - SKYLIGHT SYSTEM

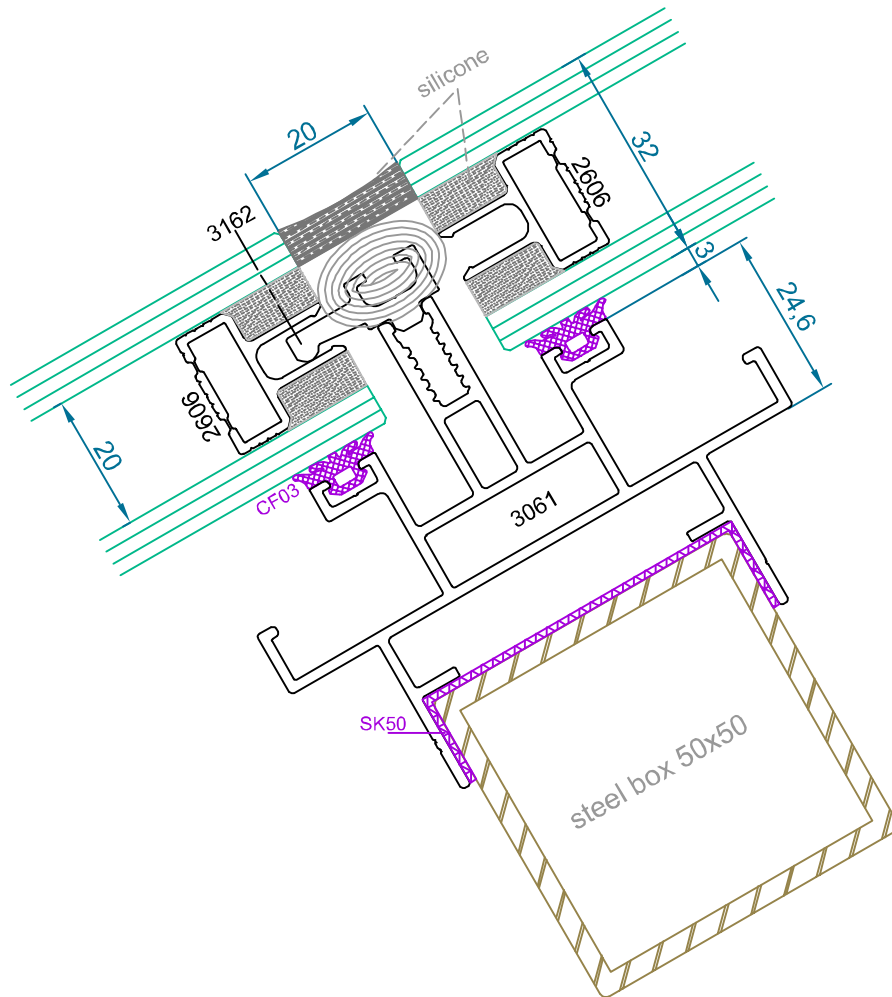
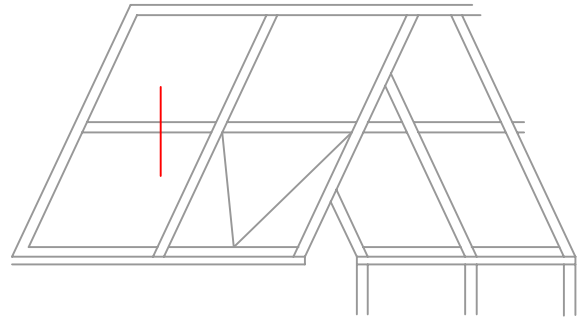

## سیستم اسکای لایت - HSK50

